

90.207

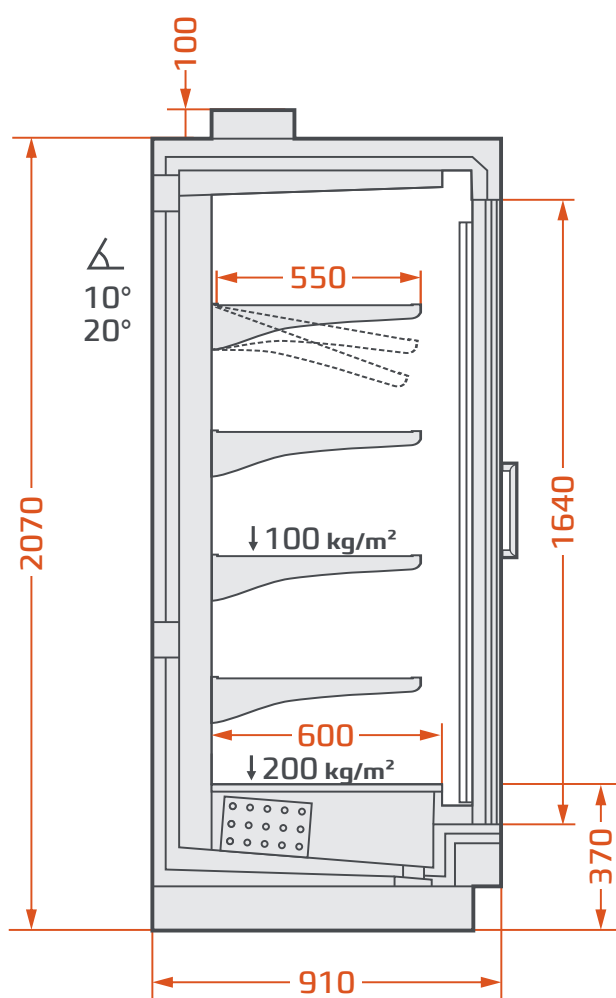

90.224

